

DigiPure 7000S

Digital Water filter

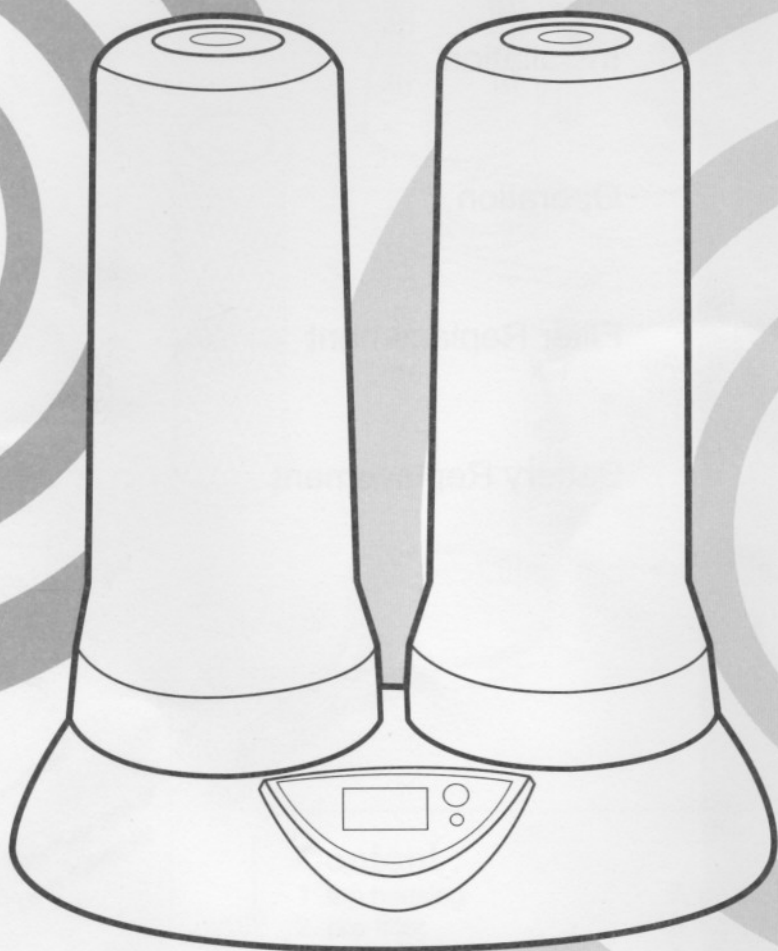

USER'S MANUAL



index

- 01 Content
 - 02 Installation
 - 03 Operation
 - 04 Filter Replacement
 - 05 Battery Replacement
- 

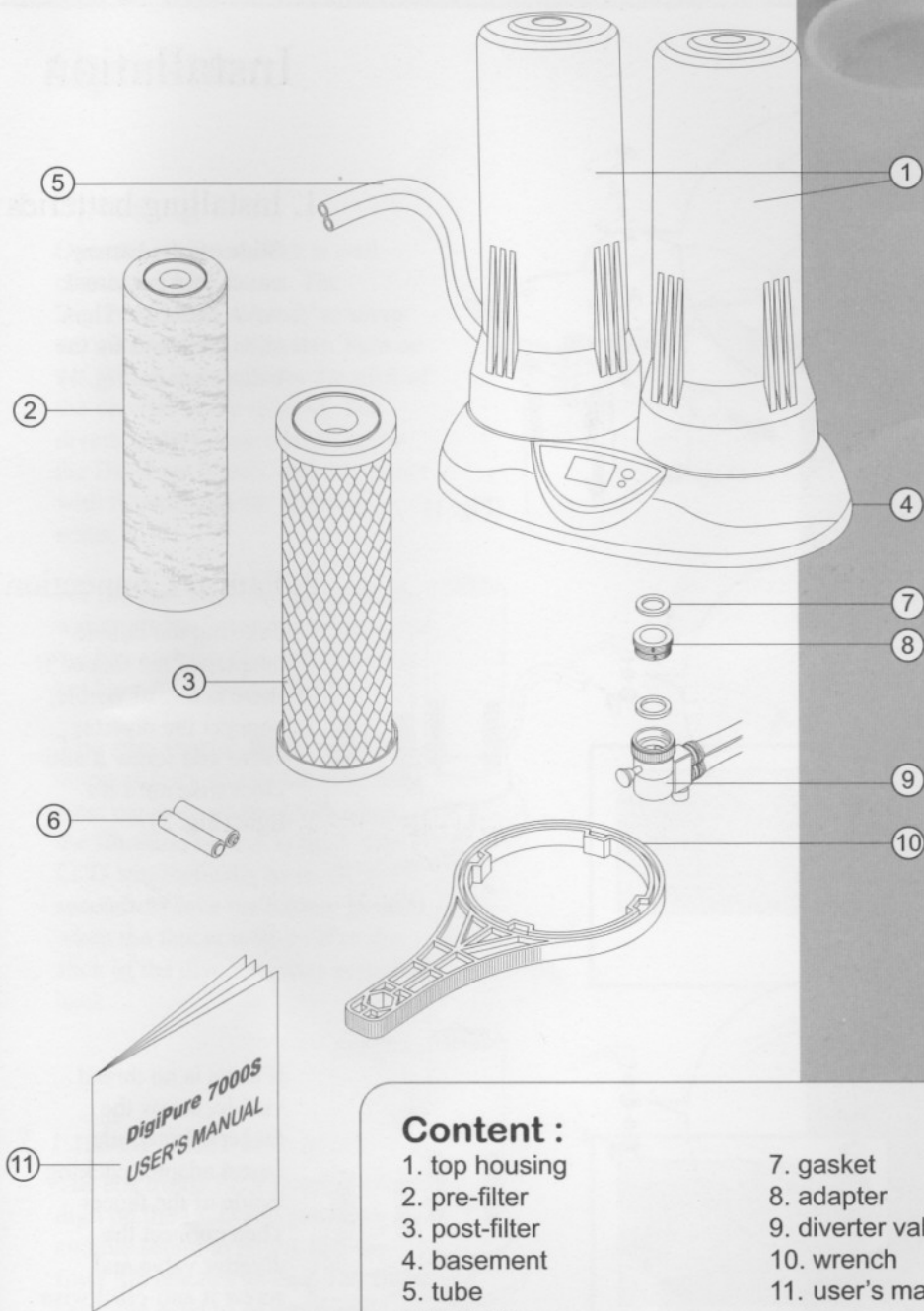

Content :

- | | |
|----------------|-------------------|
| 1. top housing | 7. gasket |
| 2. pre-filter | 8. adapter |
| 3. post-filter | 9. diverter valve |
| 4. basement | 10. wrench |
| 5. tube | 11. user's manual |
| 6. batteries | |

Installation

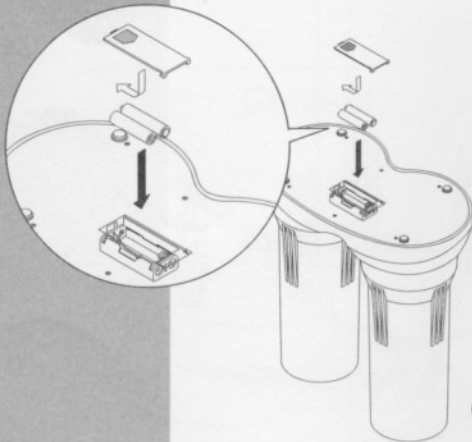

(Fig. 1)

1. Installing batteries

Slide off the battery cover, and put into 2 AAA batteries. Then slide back and fix the battery cover.(Fig. 1)

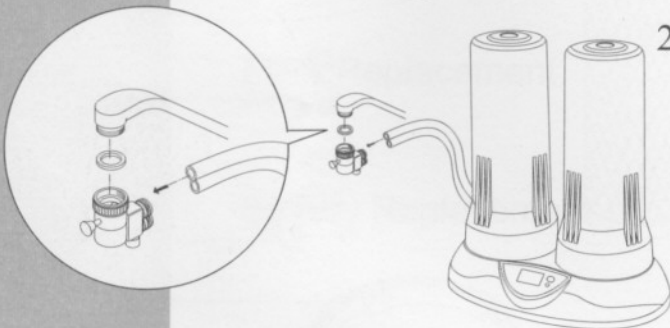

(Fig. 2)

2. Faucet Connection

Take out the bubble adapter of the faucet. If there is thread visible, connect the diverter valve and screw it anti clockwise until it's tight.(Fig. 2)

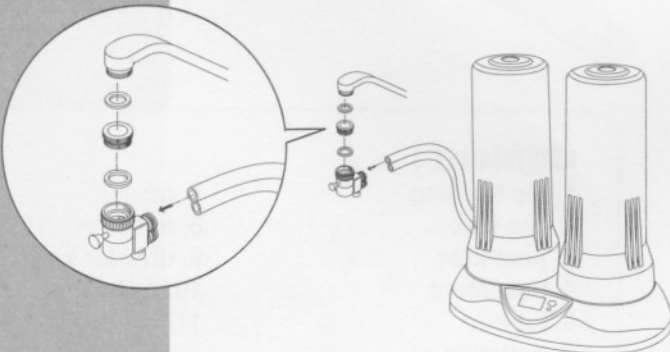

(Fig. 3)

If there is no thread visible, screw the faucet adapter and faucet adapter packing inside of the faucet. Then connect the diverter valve and screw it anti clockwise until it's tight.(Fig. 3)

Operation

1. Operating

Once the diverter valve is well connected with faucet. The DigiPure 7000S is ready to serve the quality drinking water. Turn on the faucet, then pull out the stick of the diverter valve (Fig. 4). The diverter valve divert the water to the DigiPure 7000S, and comes out with filtered, quality drinking water.

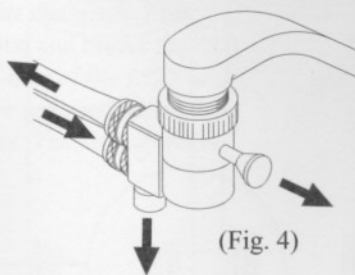

- * For the first time use, please let the water run for 5 minutes to carry out the fine carbon. The fine carbon is not harmful to human health.

The electronic filter monitor automatically shows the remaining filter capacity on the LCD when the filtration system is used. The LCD automatically turns off in 10 seconds to save the battery power when the faucet is turn off or the stick of the diverter valve is pushed back.

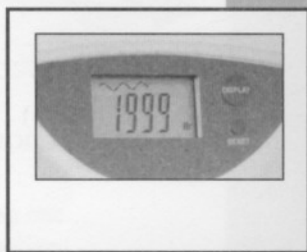

2. End of filter life alert

The electronic filter monitor blinks digit on the LCD and generates an audible sound to notice that the filter life reaches its end. The filter cartridge need to be replaced immediately for safety.

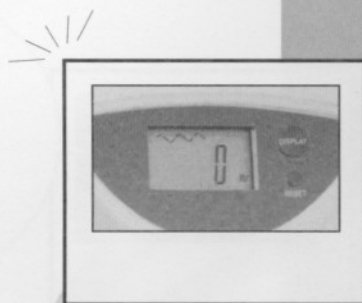

Filter Replacement

1. Replace the filter cartridge

Use the plastic wrench to twist the housing of the DigiPure 7000S counterclockwise. Take out the old filter cartridge, and replace a new one, then twist the housing of the DigiPure 7000S clockwise until snug.(Fig. 5)

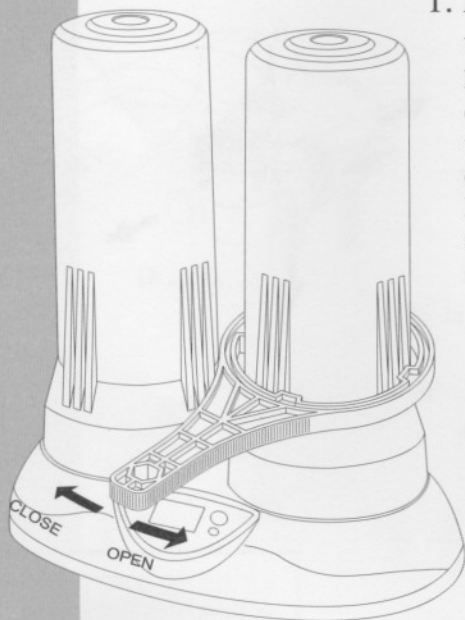

(Fig. 5)

2. Reset

After the filter cartridge is replaced, press the Reset button to reset the remaining capacity from zero to be the default value of the filter cartridge.

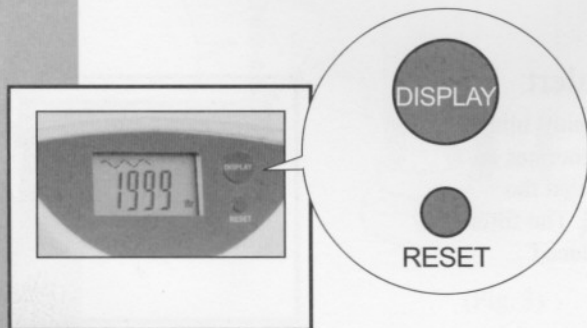

Battery Replacement

1. Low battery power alert

When the battery power is low, the electronic filter monitor generates an audible sound and blinks the battery symbol on the right-up corner of the LCD to notice that the batteries need to be replaced. Once the batteries are replaced by new ones. The alert status is automatically released.

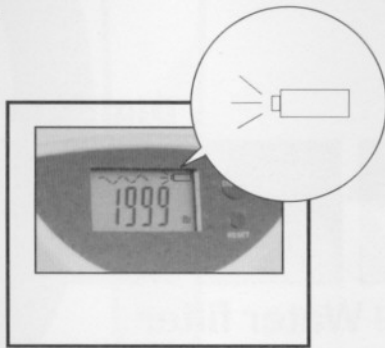

2. The last data automatically memorized

The DigiPure 7000S is operated by two AAA alkaline batteries, which power lasts more than one year. The last data will be automatically memorized when power is off.

DigiPure 7000S



Digital Water filter

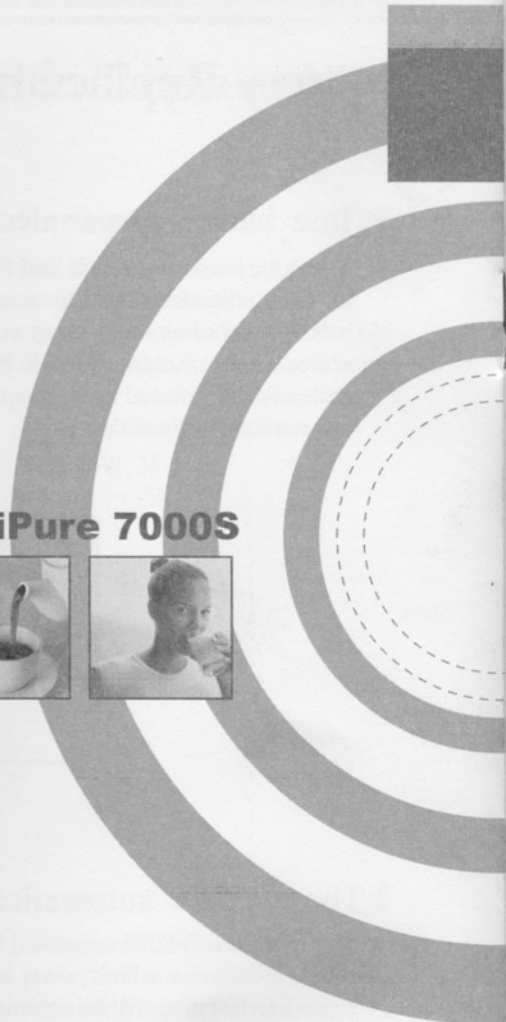

The evolutionary water filtration system